



Date: 07.02.2003

SPECIFICATIONS (provisional)

RFQ COOLER AND BUNCHER

(AND BEAM LINE SECTION ASSOCIATED)

Abstract

Developing a new RFQ cooler and buncher for ISOLDE. Such a device combines an energy loss in buffer gas atom-ion collisions with confinement provided by RF-field in transverse plane. Optional confinement in longitudinal direction is provided by static potential dwell. Then, an improvement of the beam line is achieved for all the experiments at ISOLDE. The RFQ operates inside a high voltage cage of 60 kV, and with a system of turbomolecular pumps both to keep the high vacuum before/after the RFQ and to keep a low pressure (around 0,1 mbar) inside the RFQ.

The project is to be thought not only as a mechanical design and construction project, unless as a project of research and development, since it is about improving (operationally and technically) the existing RFQ cooler and buncher placed around the world.

Due to ion optical reasons whole beam line section has to be redesigned and constructed as a part of this project.

Prepared by :
Ivan Podadera
AB/OP/ISO
Doctoral Student

Checked by :
Ari Jokinen
AB/OP/ISO
Project Leader

Mats Lindroos
AB/OP/ISO leader

Distribution:

T. Fritioff, T. Giles, A. Jokinen, J. Lettry, M. Lindroos, F. Locci, S. Meunier, J. Pier-Amory, I. Podadera, J-P. Royer, F. Wenander

History of changes

<i>Rev. No.</i>	<i>Date</i>	<i>Pages</i>	<i>Description of changes</i>
------------------------	--------------------	---------------------	--------------------------------------

Table of contents

	<i>page</i>
1. PROJECT DEVELOPMENT.....	4
2. GENERAL DESCRIPTION	5
2.1 SCHEME OF NEW BEAM LINE SECTION:	5
2.2 EXAMPLES OF RFQ.....	6
2.3 REFERENCES	6
3. TECHNICAL DESCRIPTION.....	7
3.1 RADIOPROTECTION	7
3.2 MAINTENANCE	7
3.3 SET-UP	7
3.4 RFQ COOLER AND BUNCHER	7
3.5 QUADRUPOLE 1 (present solution)	9
3.6 QUADRUPOLE 2.....	9
3.7 VACUUM SYSTEM	9
3.8 MEASURE SYSTEM	9
3.9 INSULATORS	9
3.10 CONNECTORS AND WIRING	10
3.11 HIGH VOLTAGE CAGE.....	10
3.12 BELLOWS AND VALVES	10
3.13 CONTROL SYSTEM	10
3.14 ELECTRONIC SYSTEM.....	10
4. PLANNING.....	11
5. RESOURCES	11
5.1 HUMAN RESOURCES	11
5.2 FINANCIAL RESOURCES	13
6. ANNEXE 1	14
6.1 SUGGESTIONS FOR THE CONCEPTION	14
6.2 FIRST STUDY	16

1. PROJECT DEVELOPMENT

According to ISO 9001 (development manual)

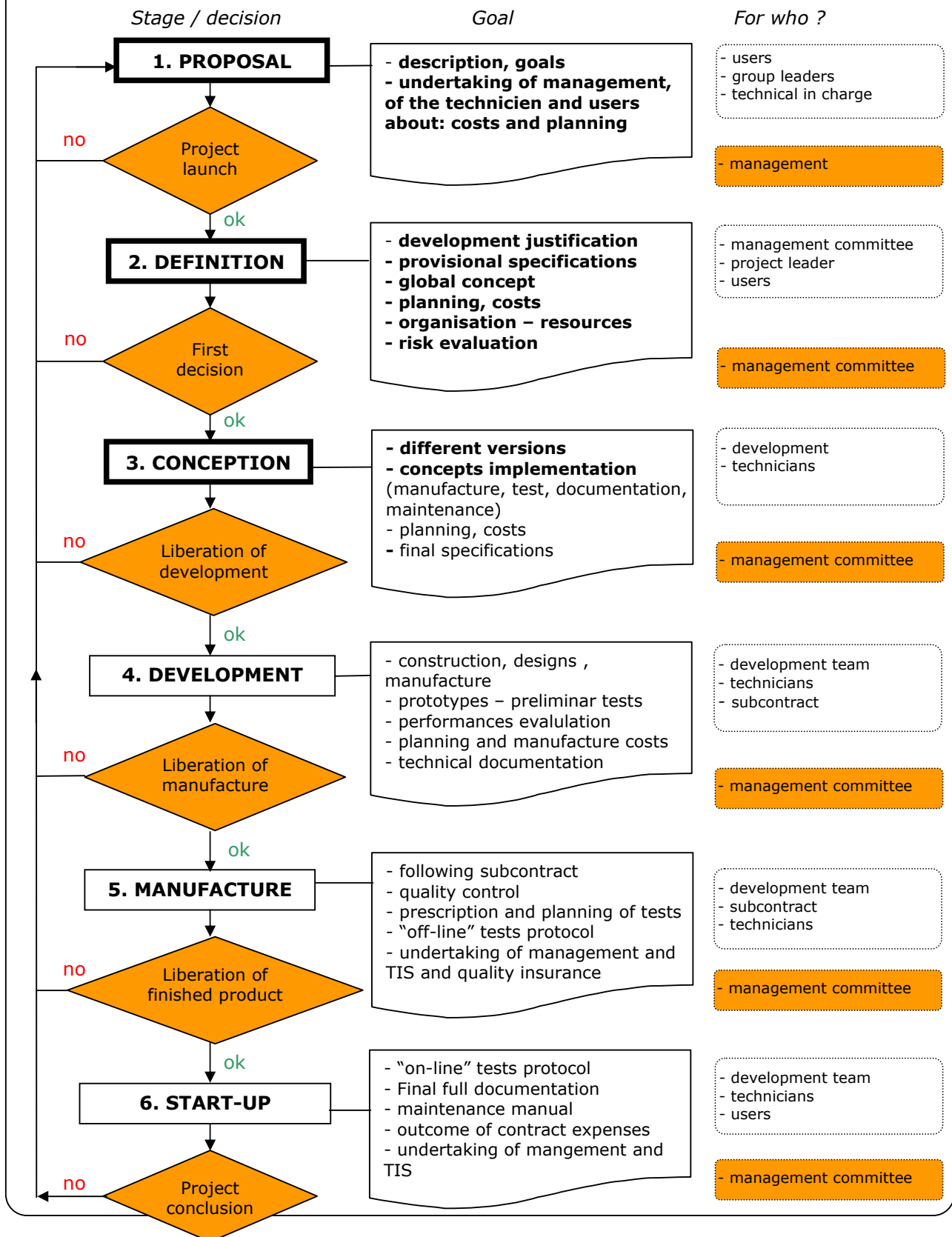

OK project finished

2. GENERAL DESCRIPTION

The future RFQ cooler and buncher is a facility to improve the quality of the radioactive beam at ISOLDE, particularly to reduce the transverse emittance and the energy spread. In addition, apparatus can be applied to produce bunched beam from an initial DC-beam provided by ISOLDE.

The place chosen is the beam line section just after HRS focus since it allows to serve the improved beam to all the experiments of the hall, while allowing beam transport from GPS to all beam lines without RFQ.

The implementation of this new facility implies the change not only of the existing quadrupole but also of all the beam line section has to be redesigned and constructed since a new optics (new quadrupole, einzel lens,...) according to the RFQ has to be installed.

2.1 SCHEME OF NEW BEAM LINE SECTION:

(see notes on next page)

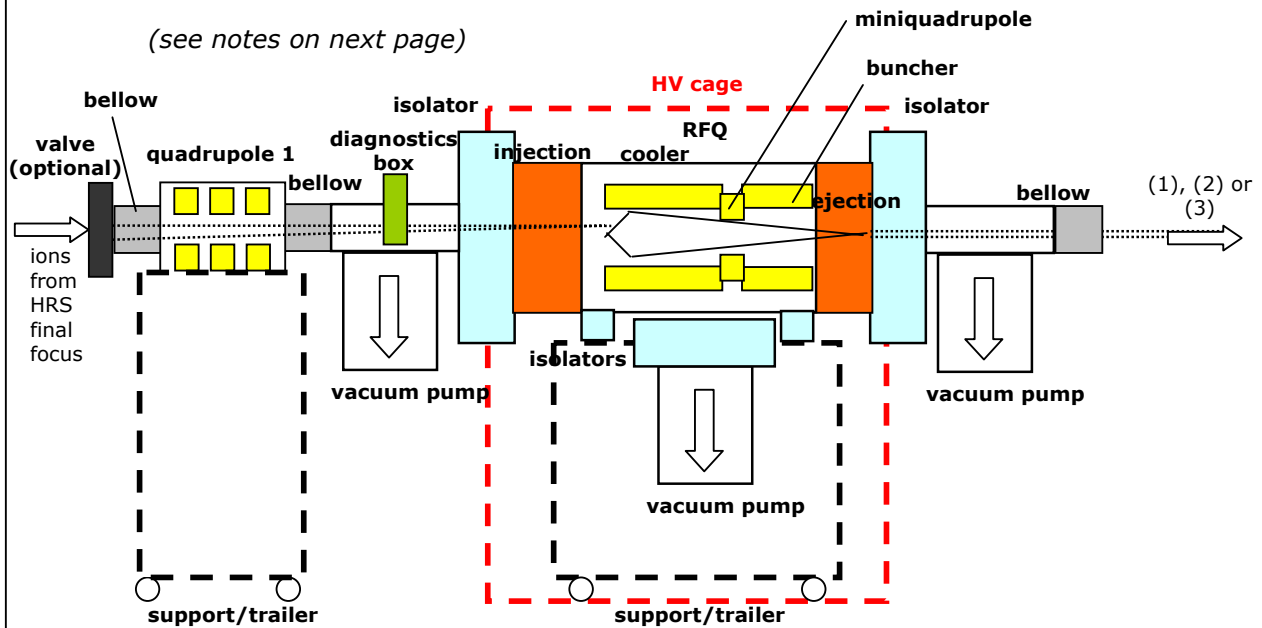

(1)

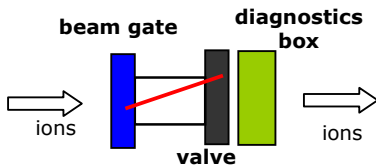

(2)

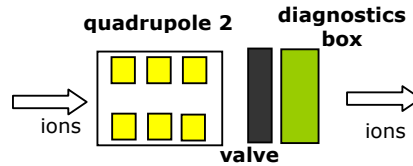

(3)

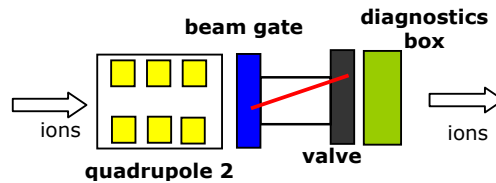

Note 1: In case beam gate can be removed or moved to another place at ISOLDE and hadn't enough space for quadrupole 2 (option 3), option 2 will be used. Unless option 1 will have to be used with the quadrupole 2 (option 2) inside the connector flange of the last vacuum pump.

Note 2: the miniquadrupole inside the RFQ will be studied during the project.

Note 3: whether the valve at the beginning of the it is necessary will be discussed.

2.2 EXAMPLES OF RFQ

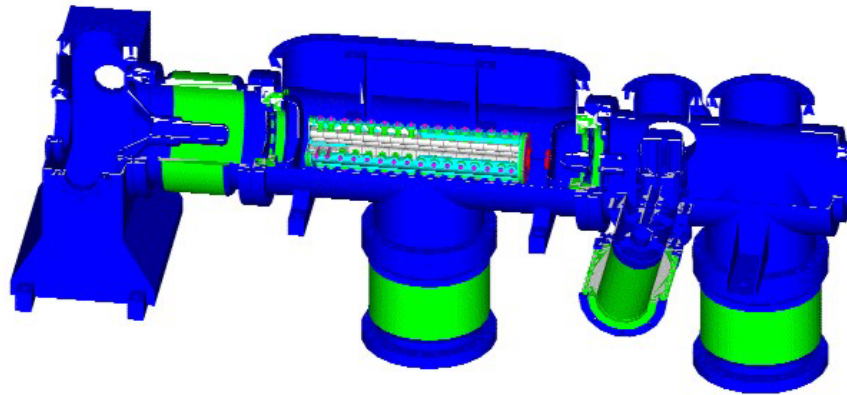

RFQ cooler and buncher at Jyväskylä

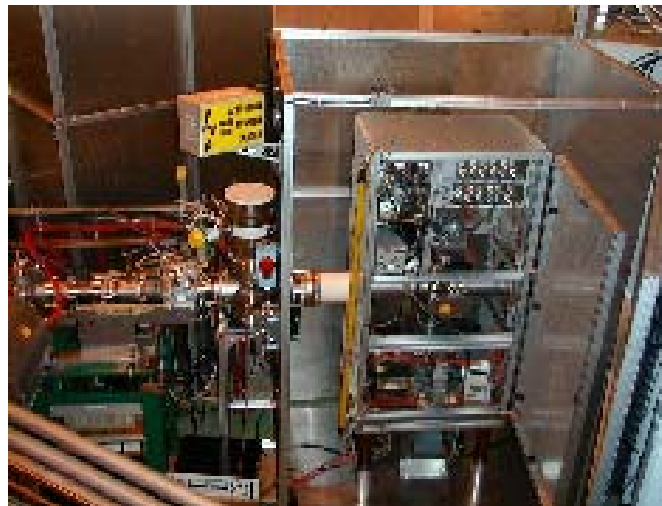

RFQ cooler and buncher at ISOLTRAP

2.3 REFERENCES

[A.Nieminen et al., Nucl. Instr. and Meth. A 469 \(2001\) 244-253.](#)

[F. Herfurth et al., Nucl. Instr. and Meth. A 469 \(2001\) 254-275.](#)

3. TECHNICAL DESCRIPTION

3.1 RADIOPROTECTION

- Dose level low but the risk of contamination of the beam line if beam gate is applied.
- Risk of contamination of vacuum system?

3.2 MAINTENANCE

- structure designed for a minimum maintenance according to the space constraints.
- use of a trailer to permit to take RFQ cooler and buncher with pumps away easily. One could describe required action and give some estimate.
- access to vacuum system as easy as possible, allowing regular service of pumps without disconnection of RFQ from the line.

3.3 SET-UP

- alignment of all the components of the beam line among them and with the sections before and after our beam line.
- easy set-up and removed using bellows and trailers for the quadrupole and the RFQ+pumps guaranteeing the proper alignment.
- use of standards pipes, flanges, screws as much as possible.
- use of flanges ISO-K $\phi 160$.
- construction of a guide to come in and out the trailers.
- first construction and "off-line" tests to be done in building 275? to ensure the mechanical ion optical and electrical operation efficiency and safety.
- an ion source will be required during the "off-line" test.

3.4 RFQ COOLER AND BUNCHER

- situated in HV platform surrounded by a HV cage.
- flexibility in respect to possible future reconfiguration of inner parts (diameter between rods, extraction of components).
- operation with mass ion beams between $10 \div 300$.
- injection ions energy: $60 \text{ keV} \pm 5 \text{ eV}$.
- initial emittance around $20\pi \text{ mm}\cdot\text{mrad}$.
- ejection ions energy: $60 \text{ keV} \pm 1 \text{ eV}$.
- entry beam intensity $< 10^{10} \text{ ions/s}$.
- final emittance around $3\pi \text{ mm}\cdot\text{mrad}$.
- efficiency (ions out/in) around 100%.
- frequency of RF field: $1 \div 5 \text{ MHz}$.
- amplitude RF field: $200 \div 1000 \text{ V}$.
- room temperature $18 \text{ }^\circ\text{C} \pm 2 \text{ }^\circ\text{C}$.
- alignment through support.

- the option of using a miniquadrupole between cooler and buncher will be studied during the project. Mechanical design has to take account this future option.
- injection:
 - 3 electrodes.
 - The voltage supply and mechanical support for second and third electrodes are to be from HV side.
 - Ground electrode: hole ϕ 12mm and 3mm wide, entering into the insulator.
 - First electrode: hole ϕ 8mm and 1mm wide.
 - Second electrode: hole ϕ 4mm and 2mm wide.
 - Distance between electrodes: 32mm (ground and first), 18mm (first and second), 12mm (second and cooler entry hole).
 - electrodes support should allow an axial adjustment of a few mm.
- RFQ cavity:
 - Pressure 0,1 mbar or less (more than 0,01 mbar).
 - Axial rods:
 - divided in ~25 segments isolated between them to provide the potential curve of the axial field.
 - the length of every different (1÷4cm) will be different: shorter in the first and last segments.
 - avoiding that the isolation material sees the field inside the RFQ.
 - Potential between 0 and -100 V, referred to HV (60 kV).
 - every group of four rods at the same potential will need one connector and one power supply but between rods 9 and 15 only one power supply could be used.
 - injection plate: hole ϕ 8mm and 6mm wide. Changeable.
 - cooler section:
 - entry ions energy around 100 eV.
 - total length chamber around 800 mm.
 - diameter between rods: 40 mm.
 - Entry hole: ϕ 8mm and 6mm wide.
 - buncher section:
 - same cavity or different electrode diameter?
 - last electrodes of the cavity (where ions are bunched).
 - Time between bunches (frequency): 10ms ÷ 1s.
 - Bunches beam intensity: ?.
 - Out hole: ?.
 - two ways to eject: just to switch off the potential, or kick (first to increase the potential in the first buncher region and after to switch off).
 - ejection plate: optics to be designed with ejection. Changeable.
- ejection: to be optimized with further calculations and based in tests in off-line test phase => *design should guarantee easy change.*

3.5 QUADRUPOLE 1 (present solution)

- use of a quadrupole triplet, of which only duplet is in use. Thus one may save 15 cm by removing third quadrupole.
- rods of 100mm length with 50mm gap between each other.
- diameter between rods: 80mm.
- focus at 318mm (RFQ injection ground electrode).

3.6 QUADRUPOLE 2

- the optics of the the extraction electrodes and this watching quadrupole is been studying presently.

3.7 VACUUM SYSTEM

- three turbomolecular pumps.
- pumping speeds: 1600 l/s for the main pump and 1000 l/s for the others.
- exhaust pipes from vacuum pumps to environment? (prepumps?).
- possibility of doubling the number of pumps to keep the system in case of breakdown of some pump.
- pressure in the high vacuum around 10^{-7} mbar (in reality higher close to injection and extraction).
- helium pressure inside the RFQ cavity around 0,1 mbar.
- helium spent: 10^{-2} mbar·l/s depending on final diameters of injection and extraction aperture.
- gas feeding from helium bottle connected directly to the cooler cavity.
- compatibility with existing ISOLDE vacuum control system.
- decision about the place for the prepumps and helium bottle?.
- baking all the system to avoid charge exchange and loss of ions.
- additional gas purification system maybe required.
- safety switch in case of high pressure danger.
- if double pumping is used, situation of pumps has to be studied (mechanical constraints).

3.8 MEASURE SYSTEM

- before RFQ (using the connector flange for the first vacuum pump).
- after existing final valve (using existing diagnostic box).
- emittance meter (depending on the current new emittance meter project has to study the proper position). Scanner won't be needed if a emittance meter is used.
- faraday cup before the RFQ.
- integration in ISOLDE control system.

3.9 INSULATORS

- insulation of 60 kV between RFQ and pipes and between RFQ and support/trailer.
- mechanical strength guaranteed.
- easily clean.

3.10 CONNECTORS AND WIRING

- use of standard flexible connectors.
- problem with electrode connections when one wants to remove the RFQ inside cavity. One should study possibilities to use integrated feedthroughs (UHV, RF compatible): 3 RF connectors X, 3 RF connectors Y and 25 DC connectors.

3.11 HIGH VOLTAGE CAGE

- safety distance between the HV cage and walls (ground element): ?
- safety switch (automatic switch off HV if someone breaks into HV cage).
- vacuum safety switch (HV down in case of high pressure).

3.12 BELLOWS AND VALVES

- bellows should permit easily the removal of all the components.
- use of standard bellows.
- existing valve at the end of the beam line section will be kept.

3.13 CONTROL SYSTEM

- RF electronics + RFQ DC power suppliers in HV voltage: remote control mandatory.
- possibility to install this HV components inside the HV cage where is the RFQ or in another HV cage in another place.
- full compatibility with ISOLDE control system.
- **main** parameters to control:
 - vacuum system (pumping speeds, pressure inside RFQ (correcting readout of gas feeding) , gas feed, pressure at injection and ejection).
 - RF voltage (frequency?, amplitude?).
 - DC voltages.
 - diagnostics (emittance, beam X-Y correction,...).

3.14 ELECTRONIC SYSTEM

power supply:

- operational voltage >60 kV.
- stability: $10^{-5} \cdot 60 \text{ kV} = 0,6 \text{ V}$.
- line power 220/230 V.
- isolation transformer:
 - voltage: 220/230 V.
 - low power.
 - voltage rate: 60 kV.
- 60 kV fast switch.
- RF field provided by a function generator:
 - amplitude: $0 \div 1 \text{ kV}$ (0 to peak).
 - frequency: $100 \text{ kHz} \div 5 \text{ MHz}$.
- 25 DC power supplies $0 \div 200 \text{ V}$.

4. PLANNING

According to stages of chapter 1.

Stage	2003												2004												2005								
	j	f	m	a	m	j	j	a	s	o	n	d	j	f	m	a	m	j	j	a	s	o	n	d	j	f							
1 PROPOSAL	█																																
2 DEFINITION		█	█																														
3 CONCEPTION -First drawings -Variants		█	█	█	█	█	█	█	█	█	█																						
4 DEVELOPMENT -Drawings -Assembly								█	█	█	█	█	█	█																			
5 MANUFACTURE -Tests off-line															█	█	█	█	█	█	█												
6 START-UP -Beam line assembly during shutdown -Tests on-line																												█	█	█	█		

5. RESOURCES

5.1 HUMAN RESOURCES

The development team is made up of:

	Role:	Nom:	person/year
Management team	<ul style="list-style-type: none"> - strategic undertakings - resources definition - financing - liberation of stages 	M.Lindroos	2% ?
Project Leader	<ul style="list-style-type: none"> - writing specifications - coordination - following project, delays and budget - organisation of meetings, protocols 	A. Jokinen, T. Fritioff	5+5%
Mechanical engineer	<ul style="list-style-type: none"> - first designs - proposal of variations - mechanical study 	J. Pier-Amory, I. Podadera	20+ 40%?

RFQ COOLER AND BUNCHER

	<ul style="list-style-type: none"> - dimensioning - choice of components - orders and following of manufacture and set-up 		
Mechanical designer	- manufacture designs	J. Pier-Amory, I. Podadera	10+30%?
Physicist	<ul style="list-style-type: none"> - calculations, optimization RFQ (RF voltage, DC voltage, vacuum,...) - beam line optics - proposal of variations 	A. Jokinen, T. Fritioff, I. Podadera, F. Wenander	8+4+4+4% ?
Electric engineer	<ul style="list-style-type: none"> - check of wiring scheme - choice and order of components (wires, connectors) - following of orders and wiring 	A. Jokinen, T. Fritioff, I. Podadera, J-P. Royer	4+2+2+2% ?
Vacuum engineer	<ul style="list-style-type: none"> - vacuum system study - dimensioning - proposal of variations - choice and order of components - following the set-up and wiring 	A.Jokinen, T. Fritioff, S. Meunier, I. Podadera	5+5+5+5% ?
Measure system technician	<ul style="list-style-type: none"> - mechanical study, electric - proposal of variations - following the manufacture and set-up 	I. Podadera, A. Jokinen, T. Fritioff	4+4+2% ?
Control system	-	A. Jokinen, I. Podadera, T. Fritioff, F. Locci	4+2+2+2%?

Besides people named above, we will need the advices and contributions of specialist under the following fields:

- users (engineers in charge, experienced physicists) – V. Fedosseev, R. Catherall, T. Nilsson
- vacuum technicien – E. Mahner, R. Gapihan
- metallurgy, materials – S. Sgobba, G. Izquierdo
- radioprotection – T. Otto, A. Muller, A. Dorsival
- mechanical engineering – S. Marzari
- mechanical fabrication (workshop) – E. Barbero, J.M. Geisser, M. Blanc
- high voltage – T. Fowler
- radiofrequency – M. Vretenar

- alignment – C. Lasseur
- several suppliers
- etc...

5.2 FINANCIAL RESOURCES

ISCC. Application BMBF (Germany).

6. ANNEXE 1

6.1 SUGGESTIONS FOR THE CONCEPTION

SET-UP	PROBLEM	CONSTRAINT	POSSIBLE SOLUTIONS
	space	Walls	<ul style="list-style-type: none"> - use of trailer for heavy components (RFQ cooler and buncher and quadrupole 1). - Only 3 pumps instead of 6. - Remove existing pumps.
		Length beam line	Combining components
	Alignment system		Alignment with 3 points
RFQ COOLER AND BUNCHER	PROBLEM	CONSTRAINT	POSSIBLE SOLUTIONS
	Design outside insulators	High voltage and length	
	Design inner insulators	Distance between high voltage electrodes and cannot "see" the electric field	
	Design injection/ejection	Distance between ground electrode and HV electrode	
	Design electrodes and cavity	Mechanical flexibility	<ul style="list-style-type: none"> - Four segmented rods (combining RF and DC field => complex electronics) - Four RF rods and four DC axial segmented rods (45° with RF rods). The RF rods will be also segmented in 3 parts with two flanges (flexibility to put a miniquadrupole between flanges).
BEAM GATE	PROBLEM	CONSTRAINT	POSSIBLE SOLUTIONS
	Space	Length	Remove fully or to move to other place
QUADRUPOLE 1	PROBLEM	CONSTRAINT	POSSIBLE SOLUTIONS
	Alignment among quads		Triplet monobloc?

RFQ COOLER AND BUNCHER

VACUUM SYSTEM	PROBLEM	CONSTRAINT	POSSIBLE SOLUTIONS
	Keep radioactive pumps	Supplier	Use Pfeiffer or Alcatel
	Breakdown of the pumps	Number of pumps	Doubling the number of pumps (problem with the space)
MEASURE SYSTEM	PROBLEM	CONSTRAINT	POSSIBLE SOLUTIONS
	Emittance meter	Dimensions	Project of new emittance meter
INSULATORS	PROBLEM	CONSTRAINT	POSSIBLE SOLUTIONS
	Fragility	Mechanical strength	
ASSEMBLY	PROBLEM	CONSTRAINT	POSSIBLE SOLUTIONS
	Alignment		
MAINTENANCE	PROBLEM	CONSTRAINT	POSSIBLE SOLUTIONS
	Access to quadrupole 1 and first vacuum pump		
RADIOPROTECTION	PROBLEM	CONSTRAINT	POSSIBLE SOLUTIONS
ELECTRIC PART	PROBLEM	CONSTRAINT	POSSIBLE SOLUTIONS
	Connection between electrodes and RFQ to remove RFQ cavity	Number of connectors	Use of a preconnection flange

6.2 FIRST STUDY

Some solutions for RFQ inner part are showed in the first study below which will be able to be useful **as basis in the discussions**:

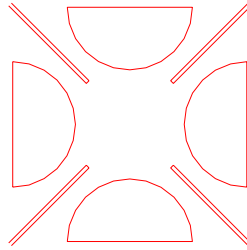

Combination of RF electrodes and axial electrodes

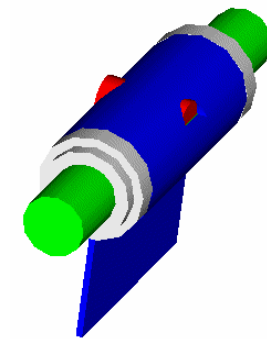

Proposal for separated axial electrodes